

Modelling and Development of Static Wireless Charging System for Electric Vehicles

Vinay Kumar Awaar^{1*}, *Sandhya Rani M.N*², *B. L. Narasimha Rao*³, *U. Pavan Kumar*⁴
*Shailendra Tiwari*⁵, *Sathish Singarapu*⁶

^{1,2,3,4}Gokaraju Rangaraju Institute of Engineering and Technology, Hyderabad, Telangana, INDIA.

⁵Uttaranchal Institute of Technology, Uttaranchal University, Dehradun, 248007, INDIA.

⁶KG Reddy College of Engineering & Technology, Hyderabad, Telangana, INDIA.

Abstract: In this work, it is proposed to develop wireless charging systems for sustainable electric vehicles. Wireless charging can transfer power from an outlet to devices without a connecting wire. Wireless electric vehicle charging is of two types; they are static wireless charging and dynamic wireless charging. The main advantages of wireless charging are that it takes less time, is more efficient, and less maintenance, and is more durable. However, the wireless charging system also has some problems, like the vehicle must be parked close to the charging pad, the installation cost, and a large battery required. Static wireless charging involves the charging of a sustainable electric vehicle while it is in a stationary position. While dynamic charging involves charging an electric vehicle in motion, charging pads are installed on the roads. In this work, the simulation model has been developed for the PS topology of wireless charging using JMAG software. This can further be developed in a prototype for EVs' static wireless charging system.

1 Introduction

Wireless power transfer (WPT) is the technology that enables the transmission of electrical energy from a power source to an electrical device without using physical wires or direct electrical contacts. In the context of sustainable electric vehicles (EVs), wireless power transfer means charging an electric vehicle's battery without a physical connection with the vehicle and the charging infrastructure.[1]

* Vinay Kumar Awaar: vinaykumaar.a@gmail.com

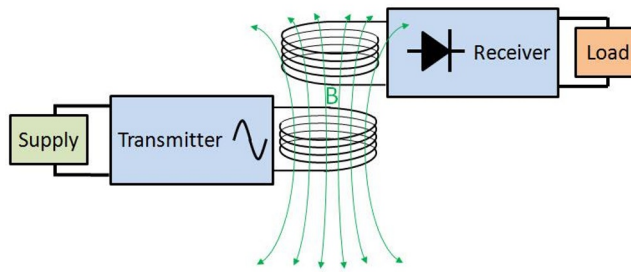

Fig 1. Wireless Power Transmission

The concept of wireless power transfer of sustainable electric vehicles is based on electromagnetic induction theory. It involves two main components: transmitter and receiver. A transmitter, typically installed in charging infrastructure, generates an oscillating magnetic field using a coil of wire.[9] The receiver, installed in the EV, contains a coil of wire tuned to resonate with the frequency of the magnetic field generated by the transmitter. When transmitter and receiver coils are nearby, the oscillating magnetic field induces an alternating current (AC) in the receiver coil through electromagnetic induction. This AC is rectified and converted into direct current (DC) to charge the EV's battery.[12] Wireless power transfer technology for sustainable electric vehicles is rapidly advancing, and it holds tremendous potential for enhancing the user experience and adoption of electric vehicles in the future. Wireless power transfer of electric vehicles offers several advantages. It provides convenience by eliminating the need for physical connections and plug-in charging. It also reduces wear and tear on charging connectors and the risk of electric shock.[9]

2 Wireless Power Transmission

2.1 Wireless power transmission block diagram

A wireless power transmission block diagram typically consists of the following components and the block diagram is shown in Fig 2. [3]

2.1.1 Components of Wireless Power Transmission

Power Source: It is a device that provides electrical energy to operate other devices, equipment, or systems. It converts one form of energy into electrical energy to supply power for various applications. *Converter:* The device that converts the electric power from one form to another, i.e., from DC to AC and AC to DC, based on the requirement.[2] *Transmitter:* A device that generates and sends electromagnetic signals or waves carrying in power wirelessly. The transmitter is responsible for converting electrical energy into electromagnetic waves and transmitting them to a receiver. *Receiver:* The main objective of the secondary coil is to capture the field lines coming from the primary coil. Additionally, a current is produced in the receiver coil and sent to the load according to the law of electromagnetic induction. *Load:* The load refers to any device or component that consumes electrical energy from a power source. It can be a single device or a combination of devices connected to a power supply.

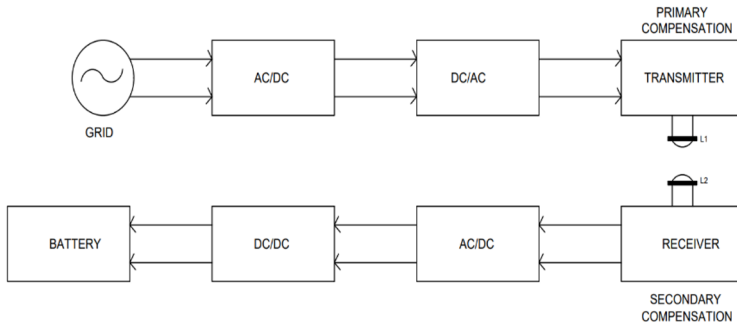

Fig 2. Block diagram of Wireless Power Transmission

2.2 Topologies of Wireless Power Transmission

2.2.1 Circuit Diagram

The circuit diagram shows the wireless power transfer's PP and PS topology connections. This is how the components are connected for WPT topologies. WPT can be arranged in SS, SP, PS, and PP topologies. In this project, PS and PP topologies are used, as shown below in Fig 3.[1] In the PP topology, the capacitor connection is in parallel with the primary and secondary inductors. In the PS topology, the capacitor connection is in parallel with the primary inductor and series to the secondary inductor.[3] PS and PP topologies are reliable power topologies. In this topology, a series inductance is required to improve inverter current management, flowing in a parallel resonant circuit to increase the efficiency of PS and PP. The primary side of the parallel compensation circuit uses the power supply to generate a sizeable primary current, while the secondary side is mainly connected to the battery.[4]

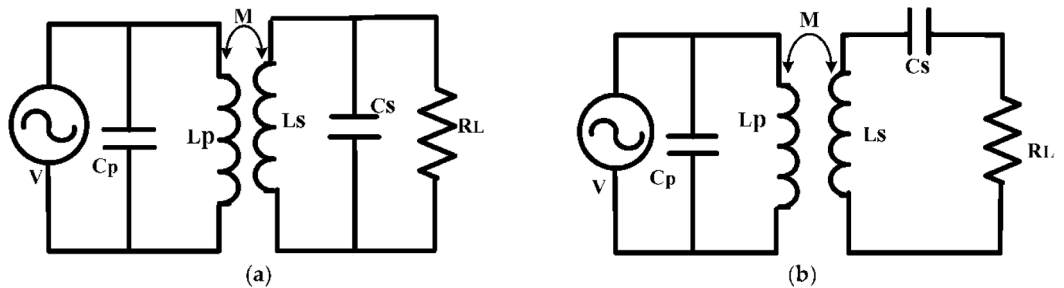

Fig 3. Circuit Topologies (a) PP type (b) PS type

2.2.2 Operation

The capacitor connection is parallel to the inductors in both the primary and secondary circuits when using the parallel-parallel (PP) topology.[10] The power sources generate alternating currents (AC) that flow through the respective transmitter coils, creating magnetic fields. To convert the induced alternating current (AC) into direct current (DC) for powering electronics or charging batteries, each receiver coil is connected to a rectifier and a smoothing capacitor on the receiving side.[4]

The rectifier rectifies the AC signal induced in the receiver coil into DC, and the capacitor helps smooth out the DC output. Similarly, in the parallel series (PS) topology, the capacitor is placed parallel in the primary circuit and series in the secondary circuit. [5] In the parallel-series topology, multiple receiver units are connected in parallel to form a receiver array. Each receiver unit consists of a series of connections of components, such as a resonant coil and a rectifier. These receiver units are then connected to the power source in parallel or transmitter.[2]

The below equations calculate the primary capacitance, secondary capacitance, and load parameters of PS and PP topologies for sustainable wireless power transfer.

For PP topology

$$C_p = \frac{1}{\omega^2 \left(\frac{(L_p - \frac{M^2}{L_s})}{\omega^2} + \frac{\frac{M^4}{L_s^4} \cdot R_{load}^2}{\omega^2 \cdot (L_p - \frac{M^2}{L_s})} \right)} \quad (1)$$

$$C_s = \frac{1}{\omega^2 L_s} \quad (2)$$

$$R_L = \frac{\omega L_s}{Q_s} \quad (3)$$

For PS topology

$$C_p = \frac{1}{\omega^2 \left(L_p - \frac{\omega^2 \cdot M^4}{L_p \cdot R_L} \right)} \quad (4)$$

$$C_s = \frac{1}{\omega^2 L_s} \quad (5)$$

$$R_L = \omega L_s Q_s \quad (6)$$

Where,

- L_p =Primary Inductance (H),
- ω =Angular frequency (Hz),
- L_s =Secondary Inductance (H),
- M =Mutual Inductance (H),
- Q_s =Secondary Quality Factor,
- R_L =Load (Ohm).
- C_p =Primary Capacitance (F),
- C_s =Secondary Capacitance (F).

3 Simulation Models of Wireless Power Transmission

3.1 Simulation for Basic Model of WPT

JMAG is a complete software package for designing and developing electromechanical equipment. With its potent simulation and analytic tools, JMAG has helped numerous businesses, colleges, and research centers worldwide advance the creation of their distinctive goods, design, development, and fields of study. JMAG is widely used in various automotive, electrical, and electronics industries to design and optimize devices and systems involving electromagnetic interactions. The imported model and circuit of this model are shown in Fig 4. The simulation was performed at seven different positions of the secondary coil in relation to the primary coil for WPT of sustainable EV battery charging. The output results of these models are seen in Figure 5.

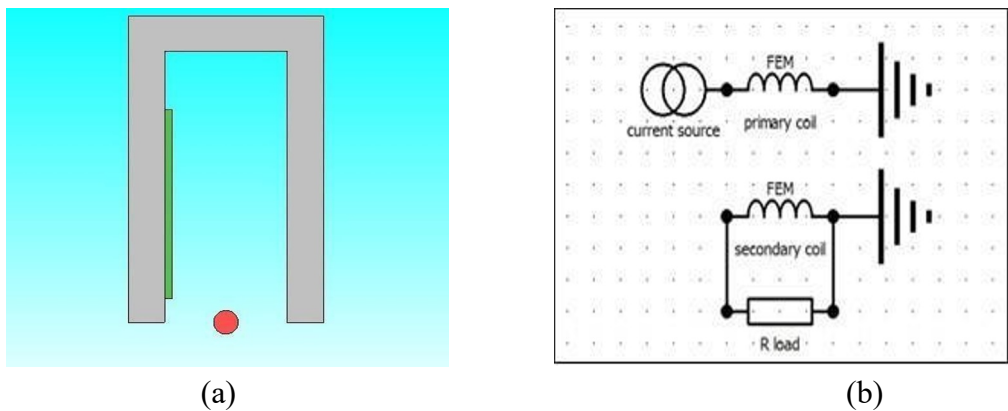
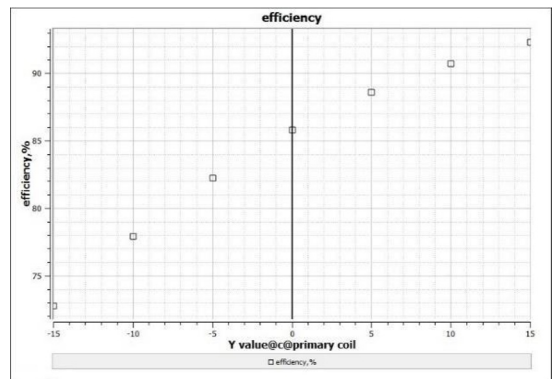

Fig 4. (a) Imported model & (b) Circuit diagram of the basic model of WPT

	value@c@primary ci	efficiency,%
1	-15	72.7901965053
2	-10	77.9224696249
3	-5	82.2721323624
4	0	85.818870866
5	5	88.5996169134
6	10	90.7118382882
7	15	92.3030309616

(a)



(b)

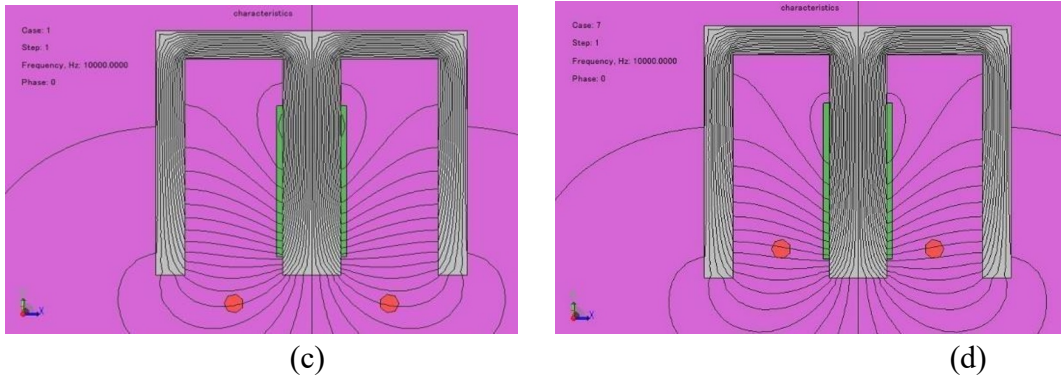

Fig 5. (a) Efficiency table, (b) Efficiency graph, (c) Flux path at case 1, (d) Flux path at case 7 for the basic model of WPT

3.2 Simulation of WPT using PS topology

In this simulation model, the PS topology circuit is used to interface with the imported model in the JMAG designer. Both the imported model and circuit are shown in Fig 6. The output results of these models are shown in Fig 7.

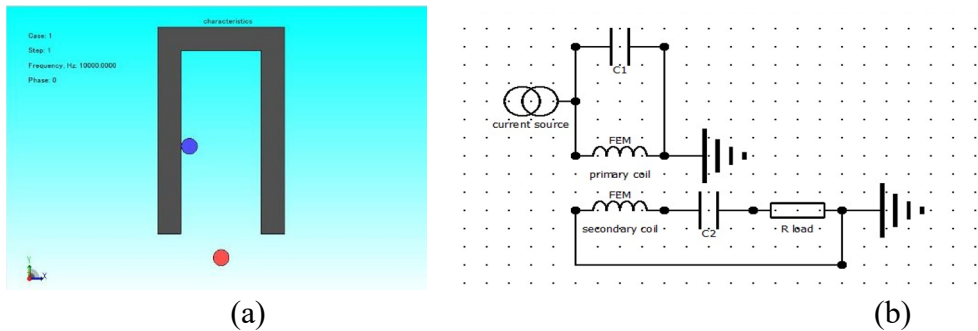
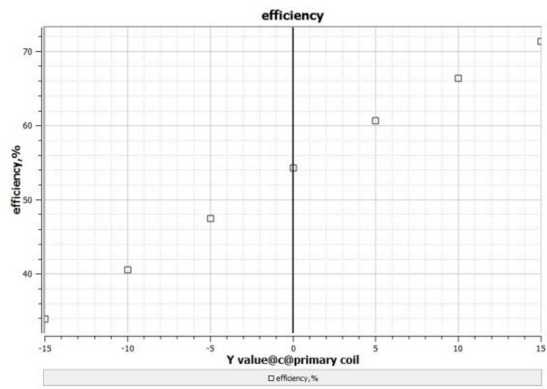

Fig 6. (a) Imported model, (b) Circuit diagram of WPT using PS topology

	value@c@primary coil	efficiency,%
1	-15	33.9684292276
2	-10	40.555078375
3	-5	47.4511016074
4	0	54.2916941168
5	5	60.6975925535
6	10	66.4259973595
7	15	71.3343779833



(a)

(b)

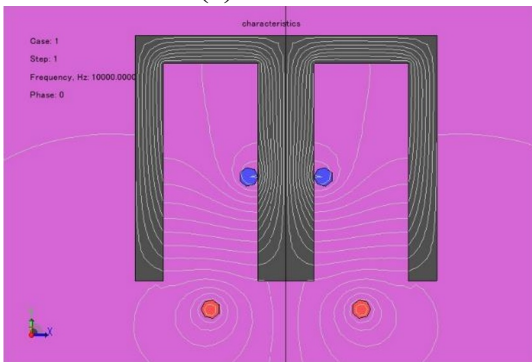

(c)

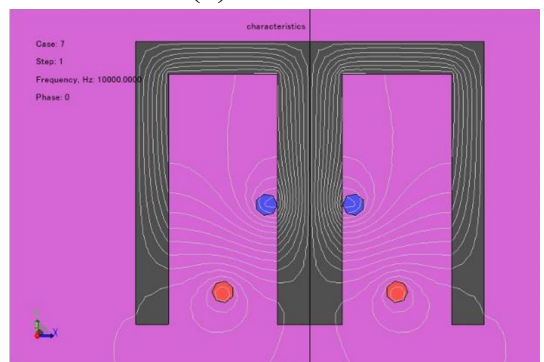

(d)

Fig 7. (a) Efficiency table, (b) Efficiency graph, (c) Flux path at case 1, (d) Flux path at case 7 of WPT using PS topology

4 Conclusion

By this, Wireless Power Transfer has many benefits and different topologies, PP, PS, SS, and SP. WPT can be done using different topologies according to the applications. In this paper, JMAG simulations were conducted to compare the efficiency of various WPT topologies. The simulation results of PS and SS topologies are compared based on efficiency. The efficiency is high when there is a short distance between primary and secondary coils, when the distance is more significant from the coils, the efficiency is low. PS topology has many benefits and the efficiency is also good. This concludes that PS topology is suitable for wireless power transfer of sustainable electric vehicles.

5 References

1. N. Mohamed et al., “*Comprehensive Analysis of Wireless Charging Systems for Electric Vehicles*”, IEEE, Apr. (2022).
2. A. Ahmad, Z. A. Khan, and M. S. Alam, “*A review of the electric vehicle charging techniques, standards, progression and evolution of EV technologies in Germany*”, Smart Sci., vol. **477**, Jan. (2018).
3. A. Triviño, J. M. González - González, and J. A. Aguado, “*Wireless power transfer technologies applied to electric vehicles*”, Energies, vol. **14**, Mar. (2021).
4. A. M. Ahmed and O. O. Khalifa, “*Wireless power transfer for electric vehicle charging,*” in Proc. 7TH Int. Conf. Electron. DEVICES, Syst. Appl. ICEDSA, vol. **2306** (2020).
5. Yadasu, Shyam, Vatsala Rani Jetti, Vinay Kumar Awaar, and Mohan Gorle. “*Development of Novel Pulse Charger for Next-Generation Batteries.*” Energy Technology 11, no. **3** (2023).
6. S. Li and C. C. Mi, “*Wireless power transfer for electric vehicle applications,*” IEEE J. Emerg. Sel. Topics Power Electron., vol. **3**, Mar. (2015).
7. Awaar, Vinay Kumar, Praveen Jugge, S. Tara Kalyani, and Mohsen Eskandari *Dynamic Voltage Restorer–A Custom Power Device for Power Quality Improvement in Electrical Distribution Systems*”, In Power Quality: Infrastructures and Control, pp. 97-116. Singapore: Springer Nature Singapore, (2023).
8. P. K. Joseph, E. Devaraj, and A. Gopal, “*Overview of wireless charging and vehicle-to-grid integration of electric vehicles using renewable energy for sustainable transportation,*” IET Power Electron, vol. **12**, Apr. (2019).
9. M. Yilmaz and P. T. Krein, “*Review of battery charger topologies, charging power levels, and infrastructure for plug-in electric and hybrid vehicles,*” IEEE Trans. Power Electron., vol. **28**, May (2013).
10. G. Rituraj, E. R. Joy, B. K. Kushwaha, and P. Kumar, “*Analysis and comparison of series-series and series-parallel topology of contactless power transfer systems,*” Oct. (2014).
11. A. Ahmad, M. S. Alam, and R. Chabaan, “*A comprehensive review of wireless charging technologies for electric vehicles*”, IEEE, vol. **4**, Mar. (2018).
12. R. Vaka and R. Keshri, “*Review on contactless power transfer for electric vehicle charging,*” Energies, vol. **10**, May (2017).
13. F. Musavi and W. Eberle, “*Overview of wireless power transfer technologies for electric vehicle battery charging,*” IET Power Electron., vol. **7**, Jan. (2014).
14. Awaar, V.K., Jugge, P. & Tara Kalyani, “*Validation of Control Platform Using TMS320F28027F for Dynamic Voltage Restorer to Improve Power Quality*”, S. Journal of Control Automation and Electrical Systems, **30**, no.4, pp 601-610, (2019).
15. Karthik Rao, R., Bobba, P.B., Suresh Kumar, T., Kosaraju, S. “*Feasibility analysis of different conducting and insulation materials used in laminated busbars*” Materials Today: Proceedings, 26, pp. 3085-3089, (2019).
16. Tummala, S.K., Bobba, P.B., Satyanarayana, K. “*SEM & EDAX analysis of supercapacitor*”, Advances in Materials and Processing Technologies, 8 (sup4), pp. 2398-2409, (2022).

17. Tummala, S.K., Kosaraju, S. SEM analysis of grid elements in mono-crystalline and poly-crystalline based solar cell Materials Today: Proceedings, 26, pp. 3228-3233, (2019).
18. Nayak, P., Swetha, G.K., Gupta, S., Madhavi, K. *Routing in wireless sensor networks using machine learning techniques: Challenges and opportunities*, Measurement: Journal of the International Measurement Confederation, 178, art. no. 108974, (2021).
19. Nayak, P., Vathasavai, B. *Genetic algorithm based clustering approach for wireless sensor network to optimize routing techniques*, Proceedings of the 7th International Conference Confluence 2017 on Cloud Computing, Data Science and Engineering, art. no. 7943178, pp. 373-380, (2017).
20. V. Tejaswini Priyanka, Y. Reshma Reddy, D. Vajja, G. Ramesh and S. Gomathy (2023). *A Novel Emotion-based Music Recommendation System using CNN*. 2023 7th International Conference on Intelligent Computing and Control Systems (ICICCS), Madurai, India, 592-596, doi: 10.1109/ICICCS56967.2023.10142330, (2023).
21. Srividya Devi Palakaluri, Srikanth Boyini and Rekha Mudundi “*ANN based LFC with Coordination strategies of DERs in Hybrid Isolated Micro-Grid Environment.*” E3S web of Conference, **309**, 01036(2021).
22. Pravalika, J. Pakkiraiah, B., Rekha, M.” Improved Performance of an Asynchronous Motor Drive with a New Modified Incremental Conductance based MPPT Controller”, E3S Web of Conferences, **309**, 01183(2021).
23. Rekha, M. Kiran Kumar, M. K “*Variable frequency drive optimization using torque ripple control and self-tuning PI controller with PSO.*” International Journal of Electrical and Computer Engineering, 9(2), 802–814(2019).
24. V. Vijaya Rama Raju, Dr. K. H. Phani Shree, Dr. S. V. Jayarama Kumar, “*Measurement Redundancy constrained Optimal PMU Locations*”, IEEE International Conference on Sustainable Energy and Future Electric Transportation, 78-1-7281-5681-1/21, organized by Gokaraju Rangaraju Institute of Engineering and Technology, Hyderabad and technically sponsored by IEEE Hyderabad Section and IEEE Industry Applications Society (IAS) from 21-23 January, 2021. (2021)
25. V. Vijaya Rama Raju, Dr. S. V. Jayarama Kumar, “*An Optimal PMU Placement method for Power System Observability*”, 2016 IEEE Power and Energy Conference at Illinois (PECI) organized by the Power and Energy Systems Group at the University of Illinois at Urbana-Champaign, USA February 19-20, 2016. (2016).
26. V. Vijaya Rama Raju, Dr. J. Praveen, “*Development of Processes and Characterization of Ferro Magnetic Materials for Manufacture of Transformer Core and Motors for Higher Efficiency*”, Elsevier, ScienceDirect Materials Today: Proceedings 5 (2018) 4016–4021. (2018).
27. Rana, A. S. Rawat, A. Bijalwan, and H. Bahuguna, in Proceedings of the 2018 3rd IEEE International Conference on Research in Intelligent and Computing in Engineering, RICE 2018 (2018).